

GÜNTER KLİMA

GÜNTER KANAL TİPİ ASPİRATÖR



Günter Kanal Tipi Aspiratör hücresi, aspiratör kapasitesine bağlı olarak 0.80 mm , 1.00 mm ve 1.20 mm kalınlığında galvanizli sacdan imal edilmektedir. Hücre köşeleri sıvama köşe parçalarıyla soğuk perçin yöntemiyle birleştirilmiş olup herhangi bir kaynak işlemi uygulanmamıştır. Bu aspiratörlerde geriye dönük geniş kanatlı radyal fanlar kullanılmaktadır. Fanların statik ve dinamik olarak balansları alındığından dolayı gayet sessiz ve titreşimsiz çalışmaktadır. Hava kanallarına yatay ve dikey olarak kolayca montajı yapılabilmektedir. Montaj yönüne göre vantilatör olarak da kullanılabilir. 50 - 18.000 m³/h debi aralığında imatları mevcuttur. Günter kanal tipi aspiratörlerde hız anahtarı kullanılabilir ve değişken debilerde çalıştırma imkanı sunmaktadır. Elektrik bağlantısı aspiratör dışındaki elektrik kutusundan yapılabilir.

TEKNİK VERİ TABLOSU

	Voltaj (V)	Frekans (Hz)	Hava Debisi (m ³ /h)	Devir (min-1)	Giriş Gücü (W)	Akım (A)	Kapasitör (mF/DB)	Sıcaklık (C)	Gürültü Seviyesi (dBA)	Ağırlık (Kg)
R2E 133-BH66-05	230	50	290	2800	24	0,11	1,0/400	45	56	0,7
R2E 175-AR72-05	230	50	490	2650	50	0,25	1,5/400	50	63	0,9
R2E 190-AO26-05	230	50	570	2500	58	0,26	2,0/400	50	62	1,2
R2E 220-AB06-05	230	50	885	2700	85	0,38	2,5/400	55	72	1,5
R2E 225-BD92-09	230	50	1200	2650	135	0,60	4,0/450	60	69	2,1
R2E 250-AS47-05	230	50	1450	2600	155	0,70	5,0/400	70	75	3,1
R2E 280-AE52-05	230	50	2110	2700	225	1,00	7,0/400	40	76	3,0
R4E 280-AD08-05	230	50	1435	1420	78	0,35	2,5/450	40	62	2,8
R4E 355-AF05-05	230	50	2365	1410	170	0,78	6,0/400	55	66	4,4
R4E 400-AB23-05	230	50	3150	1300	270	1,20	8,0/400	45	68	5,2
R4E 400-AR05-06	230	50	3100	1355	375	1,75	8,0/400	60	65	7,1
R4E 400-AN09-06	230	50	3850	1370	480	2,40	10,0/400	60	65	8,7
R4E 450-AB09-06	230	50	4450	1290	640	3,10	10,0/400	50	68	9,3
R4E 450-AK01-01	230	50	5900	1250	680	3,00	14,0/400	70	60	12,5
R4D 500-AT03-01	3~230/400	50	8300	1375	1430	5,20/3,00	---	-40..+80	77	26,0
R4D 560-AQ03-01	3~230/400	50	11900	1365	2380	8,65/5,00	---	-40..+60	81	28,0
R4D 630-AQ03-01	3~230/400	50	18000	1300	4250	13,10/7,55	---	-40..+60	82	29,0

GÜNTER KLİMA CİHAZLARI İMALAT TAAHHÜT SANAYİ VE TİCARET LTD.ŞTİ.

Esenboğa Yolu Çankırı Yolu Ayrımı 19 km. Akyurt / ANKARA

Tel: (0 312) 399 28 24 - 25 Fax: 0 (312) 399 26 95

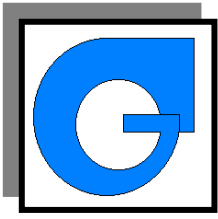

GÜNTER KLİMA

GÜNTER KANAL TİPİ ASPİRATÖR FAN EĞRİLERİ

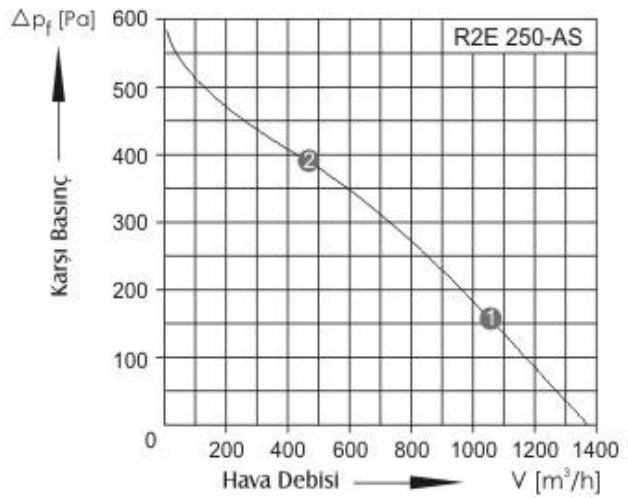
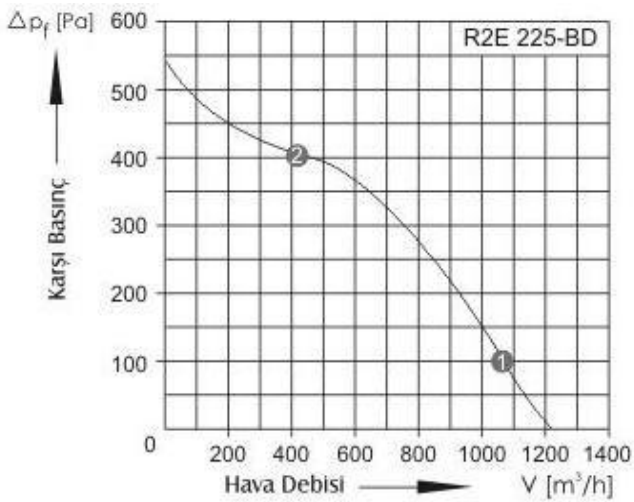
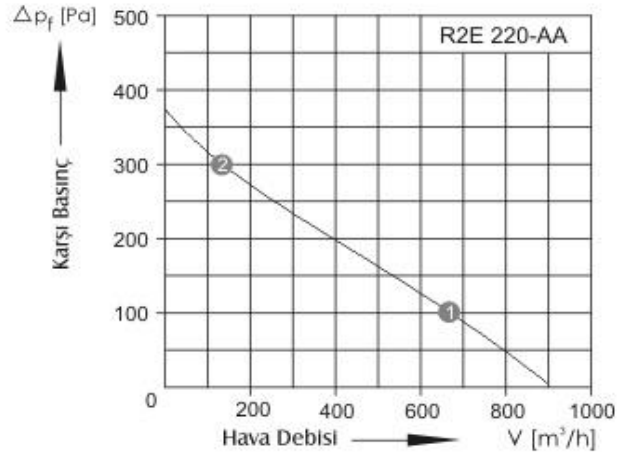
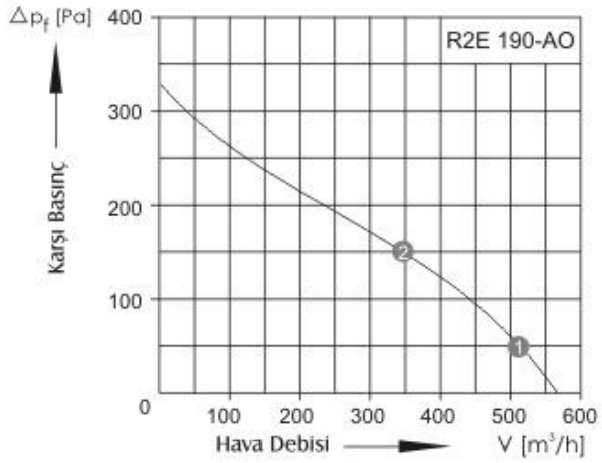
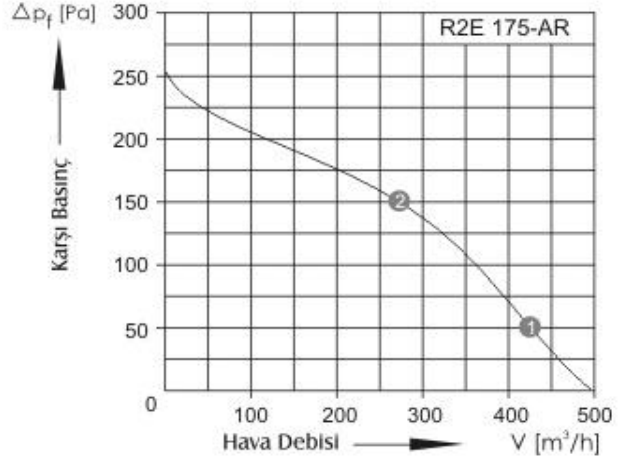
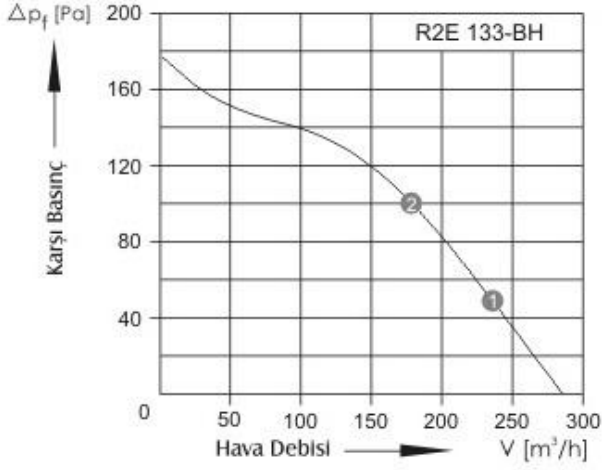

GÜNTER KLİMA CİHAZLARI İMALAT TAAHHÜT SANAYİ VE TİCARET LTD.ŞTİ.

Esenboğa Yolu Çankırı Yolu Ayrımı 19 km. Akyurt / ANKARA

Tel: (0 312) 399 28 24 - 25 Fax: 0 (312) 399 26 95

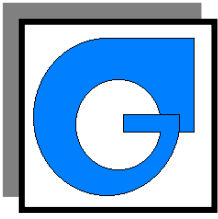

GÜNTER KLİMA

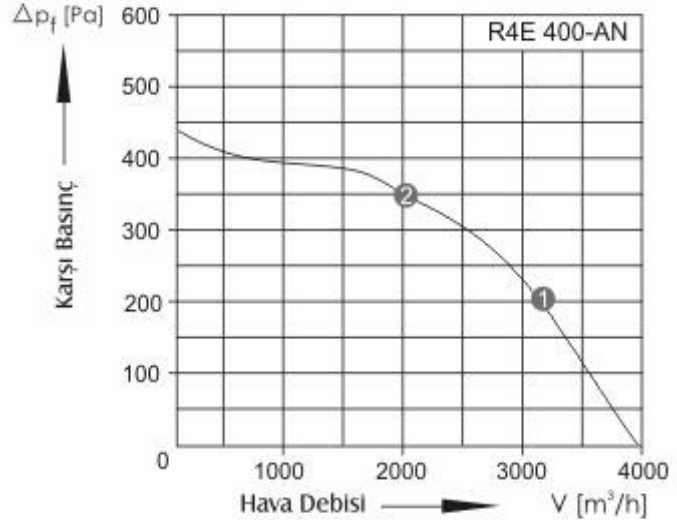
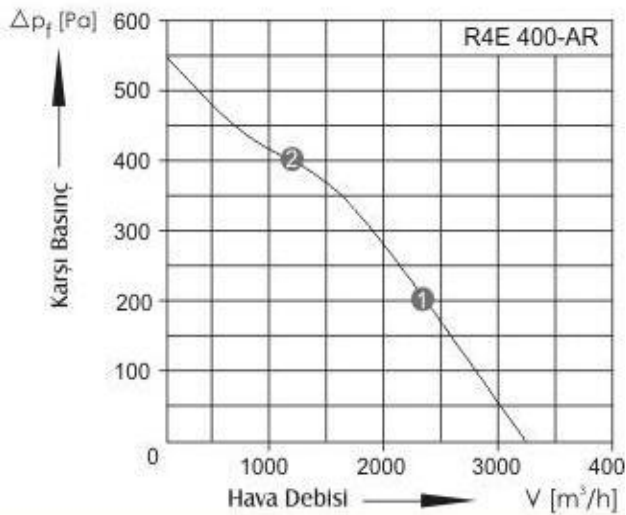
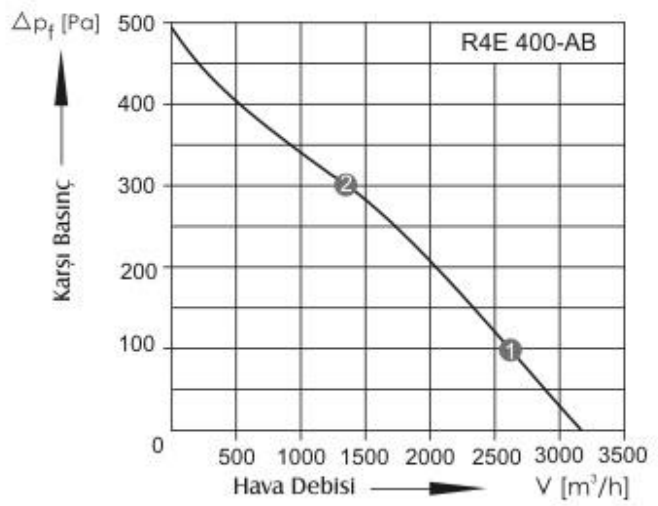
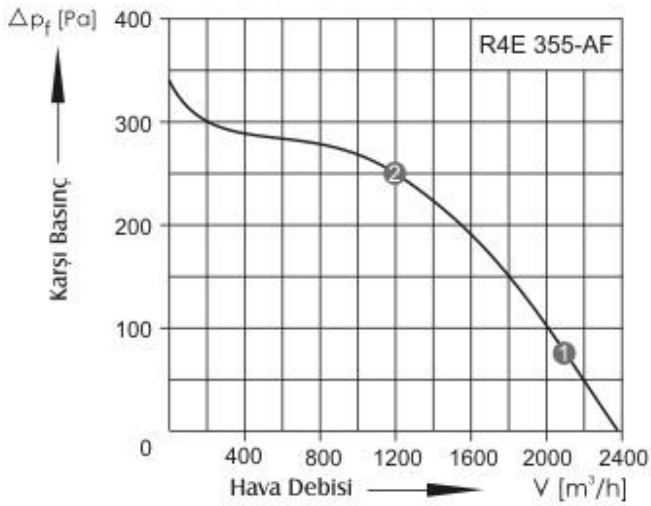
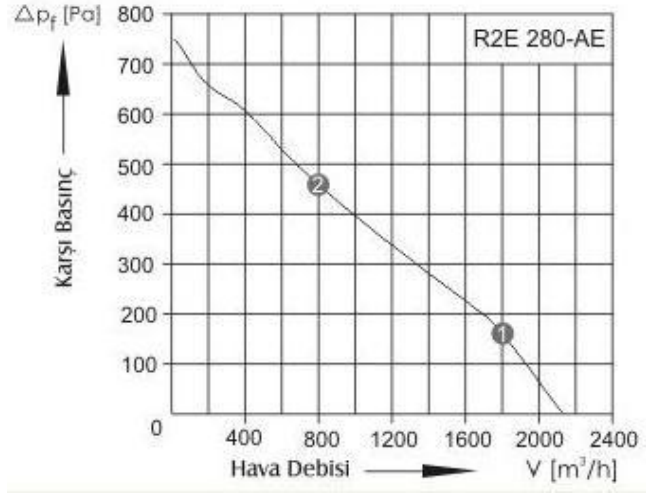
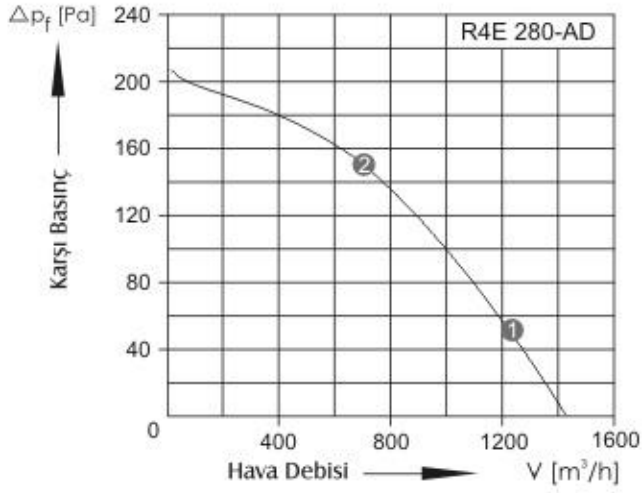

GÜNTER KLİMA CİHAZLARI İMALAT TAAHHÜT SANAYİ VE TİCARET LTD.ŞTİ.

Esenboğa Yolu Çankırı Yolu Ayrımı 19 km. Akyurt / ANKARA

Tel: (0 312) 399 28 24 - 25 Fax: 0 (312) 399 26 95

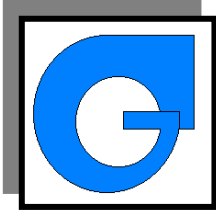

GÜNTER KLİMA

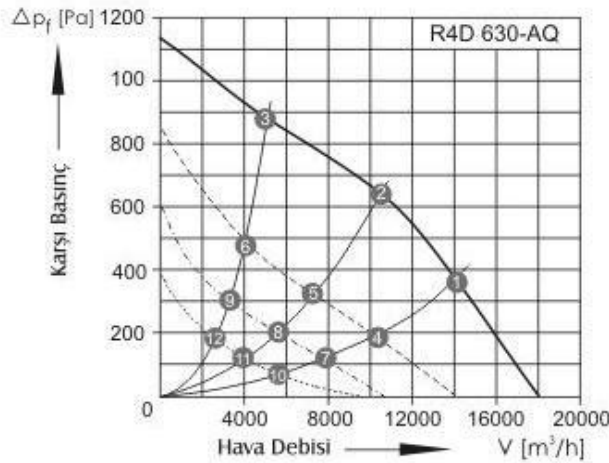
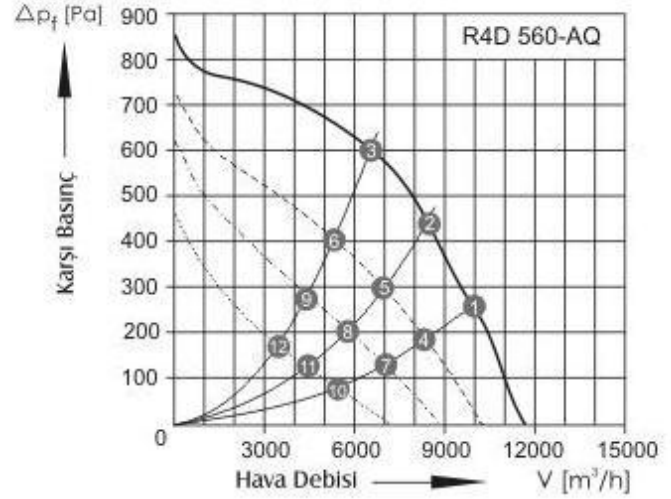
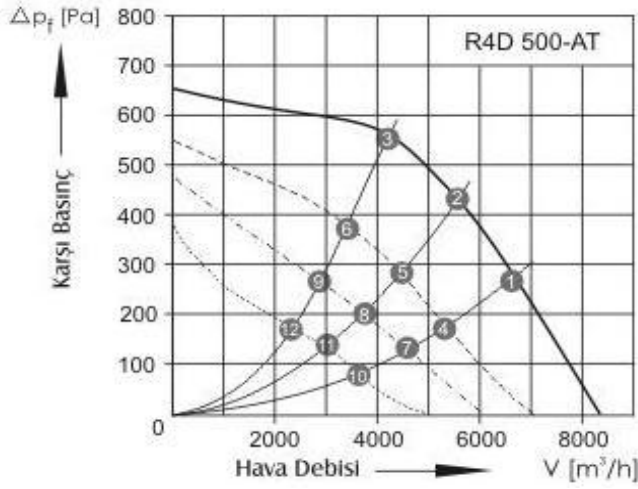
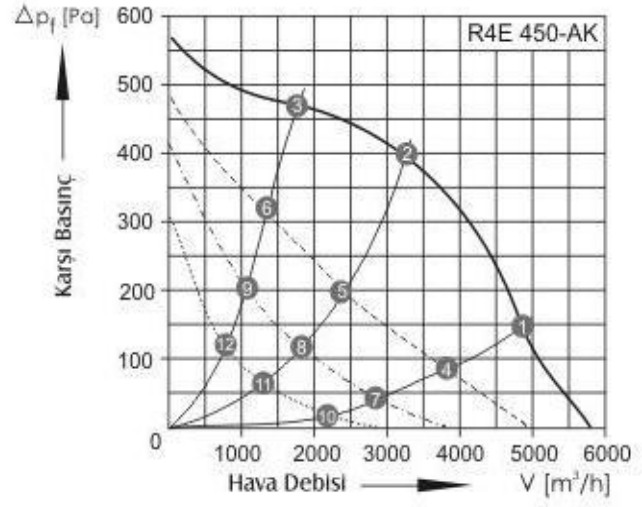
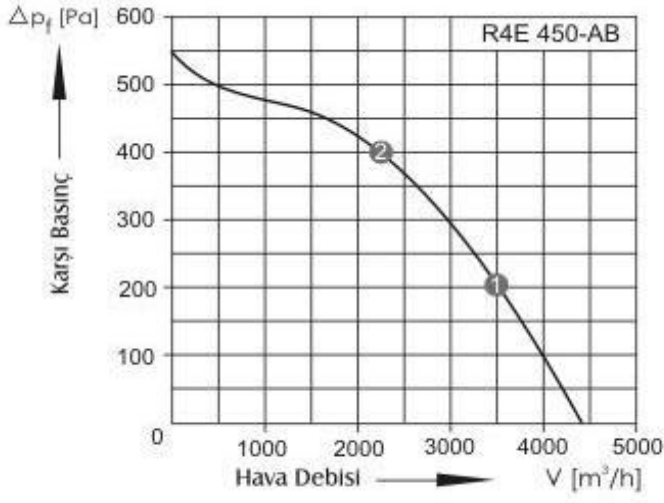

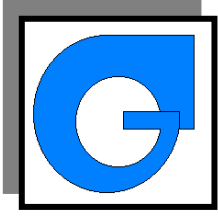

GÜNTER KLİMA

GÜNTER KANAL TİPİ ASİPRATÖR ÖLÇÜLENDİRME

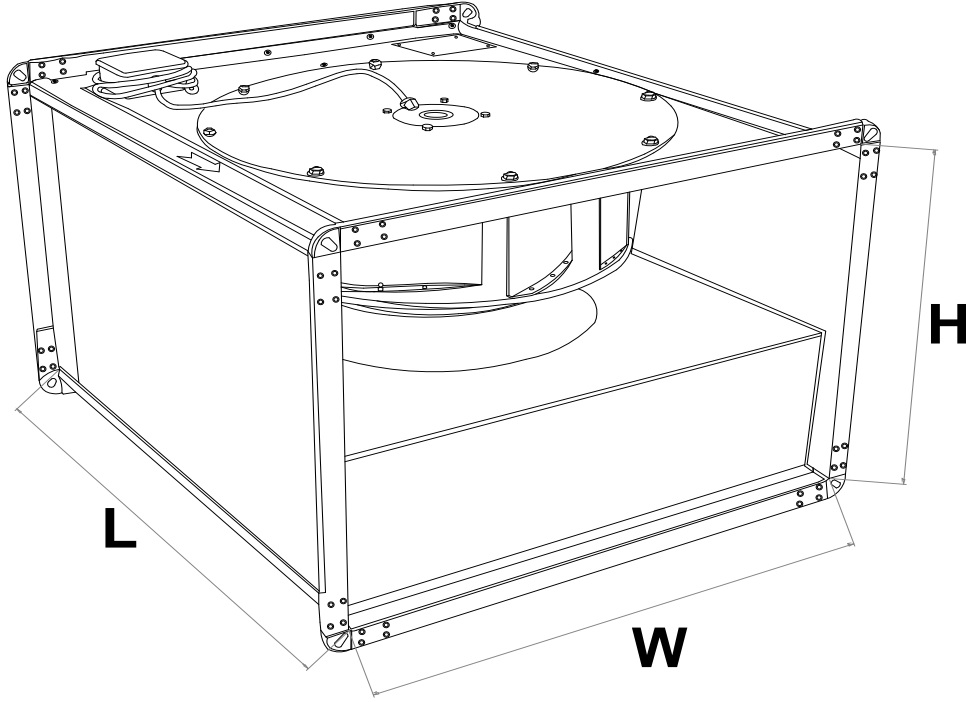

MODEL	FAN TİPİ	W (mm)	H (mm)	L (mm)
GKA-01	R2E 133-BH	300	200	300
GKA-02	R2E 175-AR	350	200	350
GKA-03	R2E 190-AO	400	250	400
GKA-04	R2E 220-AB	400	250	400
GKA-05	R2E 225-BD	400	250	400
GKA-06	R2E 250-AS	450	300	500
GKA-07	R2E 280-AE	450	300	500
GKA-08	R4E 280-AD	450	300	500
GKA-09	R4E 355-AF	500	350	600
GKA-10	R4E 400-AB	550	350	700
GKA-11	R4E 400-AR	550	350	700
GKA-12	R4E 400-AN	550	350	700
GKA-13	R4E 450-AB	600	400	750
GKA-14	R4E 450-AK	600	450	800
GKA-15	R4D 500-AT	700	500	900
GKA-16	R4D 560-AQ	750	550	950
GKA-17	R4D 630-AQ	900	600	1050

GÜNTER KLİMA CİHAZLARI İMALAT TAAHHÜT SANAYİ VE TİCARET LTD.ŞTİ.

Esenboğa Yolu Çankırı Yolu Ayrımı 19 km. Akyurt / ANKARA

Tel: (0 312) 399 28 24 - 25 Fax: 0 (312) 399 26 95